

quick reference manual

For the aleo modules

with standard frames 50mm

S18
S19
S25
S75
S79
S59

with standard frame 35mm

P18
P19

with frames for roof integration

S18 sol
S19 sol
S79 sol

◆
Please read this carefully prior to installation.
Store in a safe place for maintenance.
◆

aleo

1 This manual in other languages

Deutsch (de-DE)	Wenn Sie diese Kurzanleitung in deutscher Sprache benötigen, wenden Sie sich bitte an aleo solar, siehe Kap. 2.2.
English (en-GB)	If you require this quick reference manual in English, please contact aleo solar, see chap. 2.2.
Français (fr-FR)	Pour avoir cette notice d'installation en Français contactez aleo solar (voir chapitre 2.2).
Italiano (it-IT)	Ove necessitaste delle seguenti istruzioni d'uso in lingua italiana, vogliate gentilmente rivolgervi a aleo solar, vedi cap 2.2.
Nederlands (Benelux) (nl-BE)	Wenst u deze handleiding in het Nederlands te ontvangen, neem dan contact op met aleo solar zie hoofdstuk 2.2.
Ελληνικ (el-GR)	Εάν χρειάζεστε αυτό το εγχειρίδιο στα Αγγλικά, παρακαλώ επικοινωνήστε με την aleo solar, βλ. κεφάλαιο 2.2.

2 Product support

2.1 Detailed information

In addition to this Quick Reference Manual, aleo solar also provides further information on its website.

2.2 Contact

aleo solar GmbH

Marius-Eriksen-Straße 1
17291 Prenzlau
Germany

T +49 (0)3984 8328-0

F +49 (0)3984 8328-115

E info@aleo-solar.com

W www.aleo-solar.com

2.3 Copyright

© 2015 aleo solar GmbH

This Quick Reference Manual is protected by copyright. All rights reserved. Copying, reproduction, translation, or conversion to any type of electronic media or machine readable form, in its entirety or parts, is not permitted. An exception will be made for a backup copy for your own use.

aleo solar reserves the right to change this document without prior notice.

aleo® and aleo solar® are registered, protected trademarks of aleo solar GmbH.

3 Table of content

1 This manual in other languages 2

2 Product support 2

- 2.1 Detailed instructions 2
- 2.2 Contact 2
- 2.3 Copyright 2

4 Explanation of safety guidelines 4

- 4.1 Warnings and notes in this manual 4
- 4.2 Notes on modules 4

5 About this manual 4

- 5.1 Detailed information for installers and planners 4

6 Handling aleo modules 4

- 6.1 Intended use 4
- 6.2 Personal protection 5

7 Preparing for installation 6

- 7.1 Handling aleo modules 6
- 7.2 Safety precautions 6

8 Mechanical Installation 7

- 8.1 Mounting orientation for modules 7
- 8.2 Safety precautions 7
- 8.3 Improper mounting 7
- 8.4 Intervals 7
- 8.5 Avoiding seals 8
- 8.6 Clearance under the modules 8

9 Electrical installation 8

- 9.1 Connectors 8
- 9.2 Laying the string cables 9
- 9.3 Potential equalisation (earthing) of module frames 9
- 9.4 Lightning protection 10

10 Details of mechanical mounting 10

- 10.1 Aligning the mounting profiles 10
- 10.2 Clamp mounting for modules with standard frames 10
- 10.3 Clamp mounting for modules with Solrif® frames 11
- 10.4 Screw mounting 11
- 10.5 Insertion mounting 11

10.6 Load levels 11

10.7 Key to symbols 12

10.8 Mounting drawings for modules with standard frames 13

11 For operators: maintenance 15

11.1 Inspections 15

11.2 Review 15

11.3 Details for the inspections 15

11.4 Cleaning 15

11.5 Repairs 17

12 For operators: decommissioning 17

12.1 Safety precautions 17

12.2 Disposal 17

12.3 Returns 17

12.4 PV Cycle 18

4 Explanation of safety guidelines



This is the danger symbol. It is used in several versions in this manual to alert you to the potential risk of personal injury.

4.1 Warnings and in this manual

The danger warnings are structured as follows:

Type and source of danger.

Possible consequences of non-observance.

- Measures or prohibitions to avoid the danger.



DANGER!

DANGER indicates an imminently dangerous situation which inevitably leads to death or serious injury if not avoided.

The information on warning and cautions is structured as follows:

Type and source of danger. Possible consequences of non-observance.

- Measures or prohibitions to avoid the danger.



WARNING!

- WARNING indicates a potentially dangerous situation which can lead to death or serious injury if not avoided.



CAUTION!

- CAUTION indicates a potentially dangerous situation which can lead to slight or semi-serious injury if not avoided.

NOTE

NOTE indicates a potentially dangerous situation which can cause material damage if not avoided.

4.2 Notes on modules

The following symbol is attached to the modules:



If this symbol also appears on a danger or warning product label, it is warning you of the danger caused by electric current or voltage which can lead to personal injury if you fail to observe the instructions.

5 About this manual

This Quick Reference Manual is release 4.2 with the issue date 08/2015. The publication of this manual renders all previous releases (older than release 4.2) of this manual invalid.

aleo solar constantly strives to improve its products and their documentation. Therefore, we advise you to use the latest version of the manual at all times.

Hand over this Quick Reference Manual to the operator after installation and ensure you have confirmation of receipt.

5.1 Detailed information for installers and planners

5.1.1 Information on the aleo solar website

You can find the latest release of the Quick Reference Manual and additional information on aleo solar's website: www.aleo-solar.com.

Always use the latest version for your modules if you find a more recent release of the manual.

5.1.2 Information sources for operators

If you have any queries about the latest release, contact your aleo solar specialist partner or aleo solar directly (see Ch. 2.2: „Contact“).

6 Handling aleo modules

6.1 Intended use

6.1.1 Appropriate use

aleo modules are used for generating electrical power in stationary, photovoltaic systems which are connected to the grid. If you would like to use the modules for another purpose, such as for charging an accumulator directly, you may need additional components (e.g. string diodes).

aleo modules are suitable for installing near livestock farms and coastal regions.

Observe all the applicable legislation, regulations, guidelines and standards when installing and operating the modules.

6.1.2 Inappropriate use

NOTE

- Do not install aleo modules on vehicles and do not use them in air, space or seafaring applications.
- Do not use aleo modules if they are exposed to concentrated sunlight or strong artificial light, or if they could be immersed in water or other liquids or exposed to vapour.

6.1.3 Product-specific information

Product-specific information (e.g. the data sheet) contains details of a particular type of module.

Only use aleo modules for the intended purpose outlined in the product-specific information.

Data sheets may change without prior notice. If the information in the data sheet differs from this manual, the data sheet takes precedence.

6.2 Personal protection

6.2.1 Electrical safety precautions

DANGER!

High DC voltages during storage, installation, operation and maintenance.

Risk of fatal electric shock!

- aleo modules may only be installed by qualified technicians with a high level of expertise.

DANGER!

Dangerous, high DC voltages generated even at low levels of light, especially in a series connection.

Risk of fatal electric shock!

- Never touch the electrical connections of a solar module under any circumstances, not even if you have disconnected the photovoltaic generator.

DANGER!

Electric arcs form when electrical connections are made or disconnected incorrectly.

Severe or fatal injuries from electric shock or severe injury from burns!

- Before you carry out any work on electrical components, disconnect the photovoltaic generator.

DANGER!

Contact with live parts due to defective insulation or damaged/fallen off junction box covers.

Severe or fatal injuries from electric shock!

- Do not touch damaged parts with your bare hands.
- Use protective clothing and suitable, insulated tools.

DANGER!

High DC voltages, even when the photovoltaic generator is disconnected if the generator is earthed.

Severe or fatal injuries from electric shock!

- If the circuit of your photovoltaic generator is earthed, remove the earth before you carry out electrical work on the generator.

WARNING!

Contact with live parts due to unsuitable tools or weather conditions. Risk of electric shock!

- Only use approved, insulated tools for maintenance work on live parts.
- Work in dry conditions. Ensure that the electrical connections of the solar module, the cables and the tools, are dry.

RECOMMENDATION

Work in pairs so that in an emergency one person is able to help in the case of injury. This is because the modules generate voltage as soon as they are exposed to light. Therefore, parts of the system are nearly always energised during the daytime.

6.2.2 Mechanical safety precautions

WARNING!

Glass can crack, break or splinter. Beware of injury!

- Never step or sit on solar modules.
- Avoid knocking and bumping the surface, the edges and corners of the glass panels.

WARNING!

Exposed live parts due to damaged glass. Risk of electric shock!

- Only use modules with the insulation in perfect condition.

CAUTION!

Sharp glass edges or flying glass splinters. Beware of injury!

- Always use suitable protective equipment (e.g. gloves and goggles).
- Be especially careful with the glass edges and corners of laminates (frameless modules).

- Insulating back sheet

WARNING!

Damaged insulating back sheet. Risk of electric shock and burns!

- Avoid any contact with the back of the module with sharp or pointed objects.
- Ensure that the back sheet remains undamaged.

7 Preparing for installation

7.1 Handling aleo modules

7.1.1 Storing modules

■ Framed modules

Modules in packaging units:

NOTE

- Store the aleo modules upright in the packaging units. Make sure that each module has sufficient support.
- Do not stack the packaging units. This could damage the modules.

Individual modules:

NOTE

- Store individual aleo modules in an upright position on wedges with suitable padding. Use adequate padding between the individual modules.
- Avoid stacking individual modules, as well as the pallets they rest on.

7.1.2 Unpacking modules

■ Framed modules

NOTE

- Using an underlay, incline the pallet (e.g. with a beam, height approx. 10 cm for 5° inclination), so that the opening on the front of the box is elevated. The modules then lean back in the box which makes it easier to remove them.
- Use an underlay for inclining which supports the whole side of the pallet (e.g. a beam). This keeps the modules supported in the box along their entire width.
- Remove the module from this side only. Remove the module with the help of another person, if possible.
- Observe the unpacking instructions on the module box.

7.1.3 Checking modules

NOTE

- Before installation, check each aleo module for mechanical defects. Pay particular attention to possible damage to glass panels and insulated back sheets.
- In addition, check the insulation on the cables, connectors and junction boxes.
- If you discover any defects, report them to the supplier or transport company immediately.

7.1.4 Transporting modules to the installation site

■ Framed modules

NOTE

- Always carry the aleo module with one other person. Take hold of the module on its long sides.
- When transporting individual modules, make sure that you do not put any strain or pressure on the junction box and cables.

7.2 Safety precautions



DANGER!

When installing on roofs or other elevated sites, objects may fall down.

Severe or fatal injuries are possible!

- Block off the danger zone for people and animals before beginning installation work. If possible, remove all objects from the danger zone.



DANGER!

Electric arcs form when electrical connections are made or disconnected incorrectly.

Severe or fatal injuries from electric shock or severe injury from burns!

- Disconnect the photovoltaic generator before you carry out any work on the electrical components of the photovoltaic generator.



DANGER!

High DC voltages, even when the photovoltaic generator is disconnected, if the generator is earthed.

Severe or fatal injuries from electric shock!

- If the circuit of your photovoltaic generator is earthed, remove the earth before carrying out electrical work on the generator.



WARNING!

Exposed live parts on damaged modules. Danger of electric shock!

- Only use components which are in perfect condition for use in photovoltaic systems. Do not install solar modules with visible damage to the glass panels, the insulating back sheet or on the insulation of electrical connections.

⚠ WARNING!

Contact with live parts due to unsuitable tools or wet conditions. Danger of electric shock!

- Only use approved, insulated tools for installation or maintenance work on live parts.
- Work in dry conditions. Make sure that the electrical connections on the solar module, the cables used for installation and the tools, are dry.

7.2.1 Health and safety

⚠ CAUTION!

**Risk of slipping due to wind, rain, snow or ice.
Risk of injury due to falling or colliding with objects!**

- Avoid unfavourable weather conditions, such as strong wind or rain.
- Also avoid working on the installation site in ice and snow.
- Use the safety equipment required or recommended by local regulations, such as hard hats, steel-capped shoes with rubber soles, protective goggles, gloves or fall-protection systems.

⚠ CAUTION!

Hot module parts in strong sunlight. Risk of burning!

- Protect yourself from burning by wearing gloves and suitable clothing.

8 Mechanical Installation

8.1 Mounting orientation for modules

8.1.1 Vertical (portrait) mounting

When mounting the module vertically, make sure that the cables are facing towards the ground and the junction box is facing upwards.

8.1.2 Horizontal (landscape) mounting

When mounting horizontally, make sure that the exit holes for the cables on the module or the junction box are positioned on the inside of the photovoltaic generator. Avoid the lateral outer edges of the photovoltaic generator to minimise the effect of ambient conditions, such as wind or rain.

8.1.3 Inclination

Incline the surface of the modules at an angle of at least 10° horizontally, so that precipitation can drain off which supports the modules self-cleaning. For optimum self-cleaning, we recommend an angle of at least 15° horizontally. In case of flat installations is advisable the employment of our unframed modules.

NOTE

Avoid locations in which, over the course of the day or year, there is systematic shadowing due to neighbouring objects or buildings

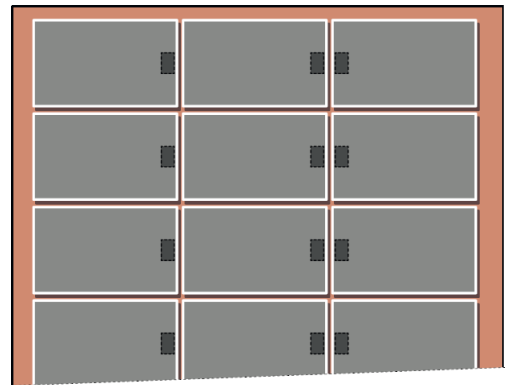

GID AS009b

Fig. 1 Recommended position of the junction boxes for horizontal mounting (facing the middle of the generator)

8.2 Safety precautions

NOTE

- Do not drill any additional holes in aleo modules or their frames.

8.3 Improper mounting

NOTE

- Do not attach the modules using nails. The vibration created in the process can cause micro fissures and loss of yield, and results in loss of warranty rights.
- Do not attach the modules by welding. The temperatures created in the process can cause delamination, micro fissures and loss of yield, and results in loss of warranty rights.

8.4 Intervals

8.4.1 Intervals between modules with standard frames

NOTE

- Leave a **minimum clearance** when mounting modules. This prevents mechanical tension due to thermal expansion.
- **When mounting at intervals**
Leave a clearance of 3 mm or more between the individual module frames.
- For **edge-to-edge mounting**
Allow for an expansion joint of 20 mm after a maximum of 7 m.
- The recommended **maximum clearance** is 30 cm, based on the modules' standard cable length.

aleo solar recommends mounting at intervals. Also note the information from the mounting equipment vendor. This could specify larger intervals.

8.4.2 Clearance under the modules

■ Minimum clearance

NOTE

• Rooftop or freefield mounting

Ensure a clearance of at least 4 cm between the rear edge of the frame and the mounting surface (e.g. the roof tiles) for the rear ventilation of the aleo module.

• Roof-integrated mounting

Ensure an appropriate interval, for example, to the trough of the mounting system. Also ensure adequate ridge ventilation, for example, with a roof ridge ventilator.

■ Maximum clearance

NOTE

- The largest **permissible** clearance is defined by national standards. This is used to design the installation on the assumed effects of wind and suction.
- The **actual** maximum clearance of an installation is determined by the sub-structure. Ensure that your sub-structure adheres to the permissible clearances.

8.5 Avoiding seals

NOTE

- Avoid the use of a seal between aleo modules and their mounting surface.
- Dry and cool operation can have a positive effect on the performance as well as the service life of an aleo module.
- Also for roof-integrated mounting, ensure good rear ventilation to minimise loss of output which results from a higher module temperature. Ensure adequate ridge ventilation, for example, with a roof ridge ventilator.

8.6 Clearance under the modules

NOTE

- Keep the space behind the laminate free of any objects. This prevents damage to the insulating back sheet and the junction box.
- Ensure that sharp or conductive parts (e.g. screws or nails) do not protrude into the space behind the module.
- If possible, take measures to prevent foreign objects (e.g. snow, ice, leaves, twigs, branches) from being able to get behind the module.

9 Electrical installation

9.1 Connectors

WARNING!

Incompatible or unsuitable connectors can overheat. Fire hazard!

- Only use connectors that are the same type and from the same manufacturer.
- Avoid using different types of connectors or ones from different manufacturers, **even:**
 - if connecting is possible
 - if the connectors have the same basic designation (e.g. “MC4”) or
 - if they are designated as “compatible”.

You can find more details on this in the next two sections.

9.1.1 Module connectors

The various module types can be fitted with the following connectors:

- Original Multicontact® MC4 (with locking)
- PV-JM601 (with locking)

You can find the specific connectors in the module data sheet.

9.1.2 Connector peculiarities

NOTE

• Original Multicontact® MC4 connectors

- Only plug original Multicontact® MC4 connectors into original Multicontact® MC4 connectors.¹

• PV-JM601 connectors

- Only plug PV-JM601 connectors into PV-JM601 connectors.

9.1.3 Replacing the connectors

You can remove the connector on a module and replace it with another connector, if necessary. You retain the manufacturing warranty if you remove and mount with approved tools in the proper way and according to the connector manufacturer's instructions.

¹ The original Multicontact® MC4 connectors are referred to as “MC4” in the data sheet.

9.2 Laying the string cables

CAUTION!

Brittle fractures in junction boxes due to contact with unsuitable connection cables: Risk of fire!

- Only use connection cables without plasticisers.

NOTE

- Avoid any tensile and pressure loads on the junction box when mounting.
- When mounting, avoid heavy tensile loads on any connectors already plugged in.

NOTE

- Bend the cables from the connector at least 4 cm after they exit from the connector.
- Bend the cables from the junction box as well, at least 4 cm after they exit from the connector.
- This keeps the cables waterproof at the cable outlet.

Observe the guidelines on laying the respective cables. Lay all cables ensuring that:

- You adhere to the minimum bend radius (e.g. 5-fold cable diameter²).
- You avoid laying near sharp corners and edges or protect the cables accordingly.
- cables must not lay between module backside and mounting system parts.
- You protect them from direct sunlight and precipitation.
- You secure the cables with UV resistant cable clips³ or other suitable cable fasteners which protect the cable insulation.
- Cables from module strings are laid as near to each other as possible to minimise the effects of being struck by lightning.

9.2.1 Weather protection

NOTE

- Lay the cables so that they exit the junction box from below. This prevents water, which runs along the cable, from collecting at the point where the cables exit the junction box.
- For modules mounted horizontally, lay the cables in a U-form away from the junction box.
- Modules mounted vertically do not usually need any additional adjustments.

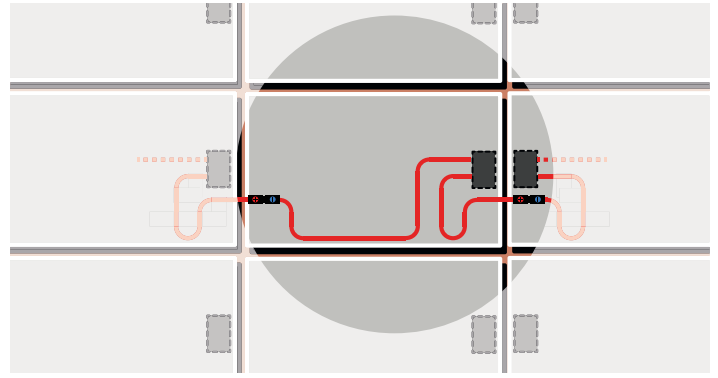

Fig.2 U-form cables at the junction box for a horizontally mounted module

Lay cables carefully to protect against damage from:

- Direct environmental factors, such as precipitation
- movement (e.g. from wind)
- Indirect environmental factors, e.g. snow or ice, which slip down behind the modules, and
- Chaffing on the insulation due to the cable moving (e.g. from wind or ice).

9.3 Potential equalisation (earthing) of module frames

NOTE

- Local regulations may specify potential equalisation (earthing).
- When earthing the module frame, establish a safe electrical connection to the earth potential or earthed sub-structure.
- Observe the requirements and recommendations of the inverter manufacturer, as well as insurance policies.
- The module frames are made of aluminium. When mounting onto other materials, take suitable measures to prevent electric corrosion, e.g. by using a coating.

NOTE

Potential equalization does not serve as lightning protection. Lightning protection may be necessary **in addition** to potential equalization.

² Some countries specify a larger bend radius, e.g. 8-fold wire diameter in the USA (NEC Codebook 2011).

³ For attaching the cable clip, use a suitable tool which can fully tighten at a defined low force. Avoid cable clips and tools which constrict or damage the cable insulation when tightening.

9.4 Lightning protection

WARNING!

**Absence of or inadequate lightning protection.
Risk of fire or electric shock!**

- Leave the planning and installation of the external, and if required internal, lightning protection to be carried out by qualified technicians at all times.
- It is essential to integrate an arrester for connecting the lightning rod with the lightning protection. This ensures the safety and reliability of the lightning protection as well as the photovoltaic system.
- Do not under any circumstances include the module frame or its earth as an active part of the lightning protection (e.g. as a lightning arrester).

NOTE

If you earth the module frame, the only task of this earth is the potential equalisation between the module frame and the supporting structure.

10 Details of mechanical mounting

10.1 Aligning the mounting profiles

10.1.1 Permissible alignment

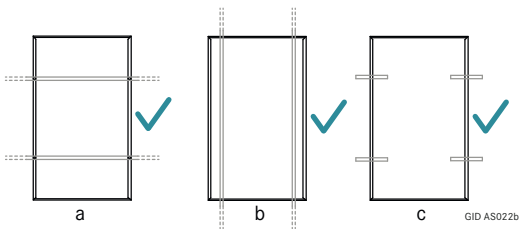

Fig.3 Permissible alignment of mounting profiles

- a, b:** Parallel profiles for mounting; **c:** Parallel, aligned fingers of a mounting system.

10.1.2 Impermissible alignment

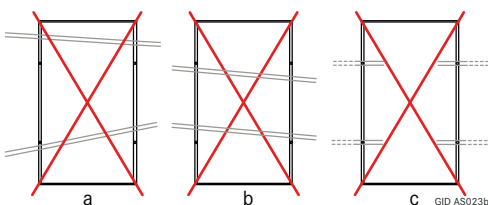

Fig.4 Impermissible alignment of mounting profiles

- a:** Profiles not parallel to one another;
b: Profiles neither parallel nor perpendicular to the module edges;
c: The profile ends for the sides of a module are not connected.

10.2 Clamp mounting for modules with standard frames

10.2.1 Arranging the clamps

■ Permissible arrangement

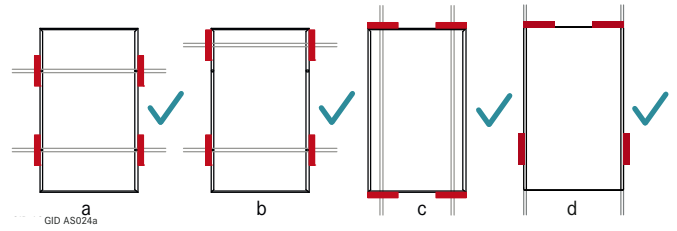

Fig.5 55 Permissible clamp arrangement for framed modules

- a:** Symmetrical clamping on the long sides,
b: Asymmetrical clamping on the long sides (acceptable for certain load levels),
c: Symmetrical clamping on the short sides.
d: Clamping on both short and long sides.

■ Impermissible arrangement

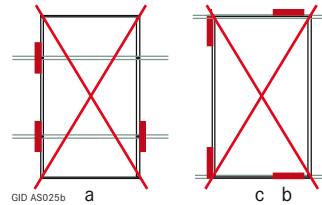

Fig.6 55 Impermissible clamp arrangement for framed modules

Impermissible clamp arrangement for framed modules (1)

- a:** Missing clamps,
b: Clamping on both short and long sides.

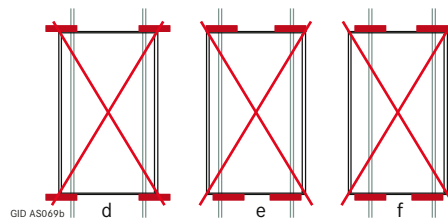

Fig.7 Impermissible clamp arrangement for framed modules (2)

- d:** Protruding clamps,
e: Opposing clamps have different distances to the module corners,
f: Asymmetrical clamps on the short sides.

10.2.2 Clamp dimensions

Observe the following information for clamp lengths and depths.

■ Clamp lengths and depths

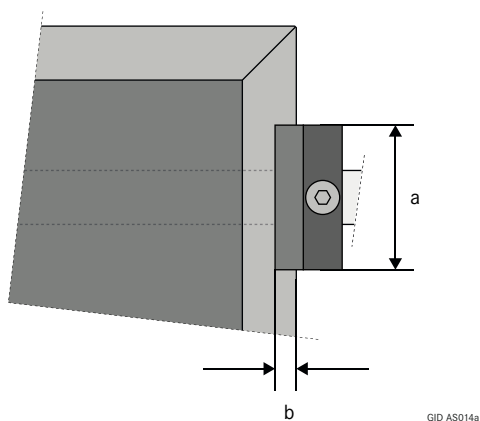

Fig. 8 Definition of clamp length and depth for framed modules

a: Clamp length, **b:** Clamp depth.

NOTE

- The required minimum length of a clamp (parallel to the frame side) is 30 mm.
- The required minimum depth of a clamp (perpendicular to the frame side) is 3 mm.
- aleo solar recommends a clamp depth of 5 mm.
- Depending on the ambient conditions (e.g. angle, suction load or tolerances of the substructure) a higher minimum area per clamp may be required.
- The clamps determine the actual clamp depth and length.
- Observe the instructions of the clamp manufacturer.

10.2.3 Tightening torque for clamp mounting

Tighten the screws on the clamp manually. If you use an automatic screwdriver, then set a suitable maximum tightening torque. You can find details for this in the manufacturer's documentation for the substructure.

10.3 Clamp mounting for modules with Solrif® frames

NOTE

- Avoid clamp mounting for modules with Solrif® frames. Only mount these modules with the Solrif® mounting system.
- You can also contact the aleo solar branch in your country. They will provide you with information on mounting systems which are already in use on a greater scale.

10.4 Screw mounting

10.4.1 Modules with standard frames

The aleo modules have the following mounting holes:

- either with a diameter of 9 mm or
- for gen2: long holes with a width of 9 mm and a length of 22.5 mm.⁴

10.4.2 Modules with Solrif® frames

NOTE

Avoid screw mounting for Solrif® modules. Only mount Solrif® modules with the Solrif® mounting system.

10.4.3 Tightening torque for screw mounting

For M8 stainless steel screws, use a maximum torque of 24 Nm.⁵

10.5 Insertion mounting

10.5.1 Modules with standard frames

Observe the manufacturer's instructions for the mounting system. Use the earthing holes for the potential equalisation.

Although edge-to-edge mounting is possible (see also Ch. 8.4.1: „Intervals between modules with standard frames“), aleo solar recommends mounting at intervals.

10.5.2 Modules with Solrif® frames

Only mount modules with Solrif® frames with the Solrif® mounting system.

10.6 Load levels

A load can be a pressure load as well as a suction load. Loads from snow and wind are grouped into three levels, which need to be taken into account wherever the module is installed. Higher load levels make the requirements for proper installation more stringent. The values listed below assume an appropriate installation.

10.6.1 Permissible loads for modules with standard frames 50mm

Load level	Permissible pressure	Permissible suction
Load level I	2400 Pa	2400 Pa
Load level II	3900 Pa	3900 Pa
Load level III	5400 Pa	5400 Pa ^a

a: For screw, clamp or lay-in system on long side.

⁴ The total length is 22.5 mm. The distance between the hole centres is 13.5 mm.

⁵ This applies to unlubricated screws with standard thread and strength class of 8.8 (minimum breaking load 29.2 kN).

10.6.2 Permissible loads for modules with standard frames 35mm

Load level	Permissible pressure	Permissible suction
Load level I	2400 Pa	2400 Pa
Load level III	5400 Pa	2400 Pa





10.6.3. Permissible loads for modules with Solrif® frames

Load level	Permissible pressure	Permissible suction
Load level I	2400 Pa	2400 Pa
Load level II	3900 Pa	2400 Pa
Load level III	5400 Pa	2400 Pa

10.6.4 Snow Load

If there is a risk of sliding snow, for load level II and III depending on mounting type (chapter 10.8), an appropriate measure has to be taken so that PV module frames on lower edge of PV modules will not be damaged (e.g. by using snow hook)

10.7 Key to symbols

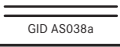
Symbol	Explanation
 GID AS034a	Permissible clamping area (criss-crossed, red)
 GID AS035a	Extra clamp required in this area (diagonally-crossed, green)
 GID AS036a	Extra support required in this area (transversal lines, blue)
 GID AS037a	Clamping point (middle of the clamp length)
 GID AS038a	Linear support
ΔH	Clearance (height) between the bottom edge of the module frame and the mounting surface in millimetres (mm).
Dimensions	All dimensions are shown in mm. Note: drawings are not always true to scale. The numerical values are binding.

10.8 Mounting drawings for modules with standard frames

10.8.1 Modules S18, S19, S79, S59

Load levels I and II

	Bolting - horizontal/vertical -	Clamping - Long module side, h./v. -	Clamping - Short module side, h./v.-	Clamping - Long and short module side, h./v.-	Lay-in system - Short side, h./v. -	Lay-in system - Long side, h./v. -
Load level I (pressure, suction) Up to 2400 Pa (approx. 240 kg/m ²)		Option 1: 	Option 2: Assymetrical clamping 			
Load level II (pressure, suction) Up to 3900 Pa (approx. 390 kg/m ²)						

Fig.9 Mounting drawing for modules S18, S19, S79 at load levels I and II
Dimensions in mm. For a lay-in system, also refer to Ch. 10.5: „Insertion mounting“.

Load level III

	Bolting - horizontal/vertical -	Clamping - Long module side, h./v. -	Clamping - Short module side, h./v. -	Clamping - Long and short module side, h./v.-	Lay-in system - Short side, h./v. -	Lay-in system - Long side, h./v. -
Load level III (pressure, suction) Up to 5400 Pa (approx. 540 kg/m ²)	ΔH < 45 mm 	Option 1: 	Option 2: Assymetrical clamping 			
	ΔH ≥ 45 mm 					

Fig.10 Mounting drawing for module S18, S19, S79 at load level III
Dimensions in mm. For a lay-in system, also refer to Ch. 10.5: „Insertion mounting“.

⁶ On lower frame part against sliding show.

10.8.2 Module S25, S75

■ Load levels I and II

	Bolting - horizontal / vertical -	Clamping - Long module side, h/v -	Clamping - Short module side, h./v.-	Lay-in system - Short side, h./v. -	Lay-in system - Long side, h./v. -
Load level I (pressure) Up to 2400 Pa (approx. 240 kg/m ²)		Option 1: Option 2: Asymmetrical clamping For 272 ≤ a ≤ 300 select: b ≥ 240 and c ≥ 800. a and b can be exchanged.		 only for on-roof or free-field installation	
Load level II (pressure) Up to 3900 Pa (approx. 390 kg/m ²)				 only for on-roof or free-field installation	

Fig. 11 Mounting drawing for module S25, S75 at load levels I and II
Dimensions in mm. For a lay-in system, also refer to Ch. 10.5: „Insertion mounting“.

■ Load level III

	Bolting - horizontal / vertical -	Clamping - Long module side, h/v -	Clamping - Short module side, h. / v. -	Lay-in system - Short side, h. / v. -	Lay-in system - Long side, h. / v. -
Load level III (pressure) Up to 5400 Pa (approx. 540 kg/m ²)		Option 1: 	 Note: max. permitted suction load 3900 Pa !	 only for on-roof or free-field installation max. suction load 3900 Pa !	
		Option 2: Asymmetrical clamping 			
ΔH < 45 mm					
ΔH ≥ 45 mm					

Fig. 12 Mounting drawing for module S25, S75 at load level III
Dimensions in mm. For a lay-in system, also refer to Ch. 10.5: „Insertion mounting“.

10.8.3 Module P18, P19

■ Load level I

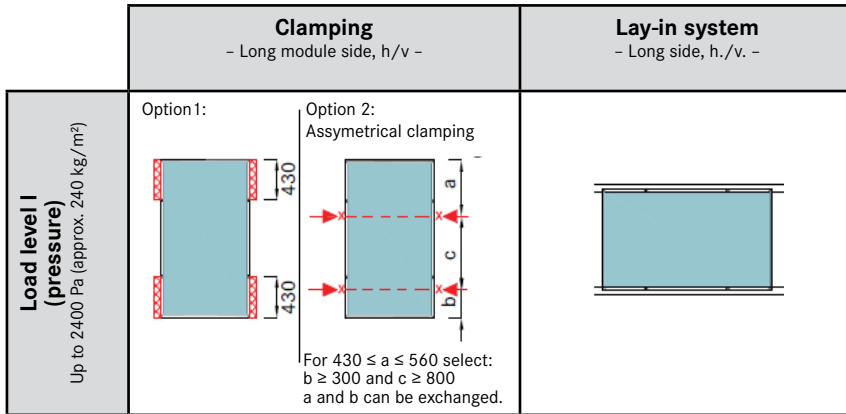

Fig. 13 Mounting drawing for module P18, P19 at load level I
Dimensions in mm. For a lay-in system, also refer to Ch. 10.5: „Insertion mounting“.

■ Load level III

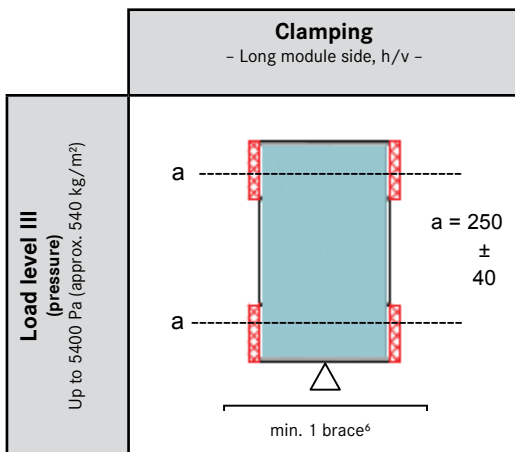

Fig. 14 Mounting drawing for module P18, P19 at load level III
Dimensions in mm. For a lay-in system, also refer to Ch. 10.5: „Insertion mounting“.

11 For operators: maintenance

NOTE

Inspect and maintain your system to:

- Keep it safe and reliable
- Achieve top output
- Prevent damage and
- Protect your investment.

aleo solar recommends carrying out regular inspections and maintenance so that any problems can be discovered reliably, and rectified.

RECOMMENDATION

- aleo solar explicitly recommends annual inspections and a more thorough inspection and measurement every 4 years.
- We also recommend the use of a monitoring system to identify any outages or problems quickly.
- Inspecting the output of your photovoltaic system regularly can help to discover problems promptly, and ensures your photovoltaic system operates at top performance, preventing loss of output.

For the proper maintenance and repair of your aleo solar photovoltaic system, contact your aleo solar dealer or get in touch with aleo solar directly (see Ch. 2.2: „Contact“).

11.1 Inspections

aleo solar recommends an inspection every year. This should be a visual inspection. Refer to Ch. 11.3: „Details for the inspections“.

The inspection includes the following aspects.

11.1.1 Inspecting the generator

- Strings: condition of the insulation and mounting
- Condition of the junction box
- Condition of the visible connectors
- Condition of the earthing conductors
- for direct earthing: connection of the earthing conductors on the frames
- for indirect earthing: connection of the frames to the sub-structure and the earthing conductors to the sub-structure
- Condition of the mounting system (in peripheral area)
- Dirt on modules: type and degree of dirt
- Shade circumstances (e.g. from trees or neighbouring houses)

Clean the components, if necessary.

11.1.2 Inspecting the documentation and drawings

- Checking the module string plan⁷,
- Check the inverter's status reports
- Determine and archive the annual output
- Create and archive the inspection report.

11.2 Review

aleo solar recommends carrying out a thorough review at least every 4 years. This includes the following work **in addition to the inspection:**

- Measure the characteristics of individual strings (MPP current I_{MPP} , open-circuit voltage U_{OC} , power output P_{MPP});
- Measure the insulation resistance R_{IS} ^{8, 9};
- Evaluate the annual power output and compare the data with earlier readings;
- Create and archive a review report.

Check, repair or replace components, if required. Refer to Ch. 11.3: „Details for the inspections“.

11.3 Details for the inspections

11.3.1 Mechanical inspection

■ Safety precautions

Refer to the notes in Ch. 6.2.2: „Mechanical safety precautions“.

■ Work steps

During the inspection, check that the mechanical connections are clean, securely fitted and properly intact.

11.3.2 Electrical inspection

■ Safety precautions

Make sure you refer to the notes in Ch. 6.2.1: „Electrical safety precautions“.

■ Work steps

During the inspection, check that the electrical connections are clean, securely fitted and properly intact.

Identify any defects or irregularities in the electrical installation and make a record of them. Then rectify the problem as quickly as possible.

11.4 Cleaning

Depending on the ambient conditions, modules are likely to get soiled more or less heavily over time. This can cause reduced output.

⁷ Suggestion for external inspectors: perform a spot check to ensure that the module string plan matches the installation.

⁸ According to the standard IEC 61215, a photovoltaic module should have an insulation resistance of at least $40 M\Omega \cdot m^2$.

⁹ Some inverters provide the measured insulation resistance via an interface.

Dirt could be:

- Dust, pollen or seed
- Leaves or twigs
- Deposits from stable vapour
- Moss, algae, fungi or bacteria growing on deposits (in short: biofilms)
- Salt (in coastal regions)

11.4.1 Safety precautions



CAUTION!

Contact of live parts with water. Risk of electric shock!

- Never use a high pressure cleaner.

NOTE

You will also retain the manufacturer's warranty as a result of this measure.

11.4.2 Glass surfaces

NOTE

- The glass surfaces of aleo modules have microscopic structures or anti-reflex coatings. Ensure that these do not get damaged. Do not use any cleaning agents which will polish or scratch the surface.
- Avoid the use of very hard water.
- Also avoid the use of distilled or demineralised water if possible.¹⁰
- Avoid the use of acids, bases or other aggressive cleaning agents.

NOTE

Dirt- or water-repellent coatings subsequently applied to the modules can negatively affect the efficiency of the aleo modules and therefore the power output of the whole photovoltaic system. We therefore advise against the use of these agents.

RECOMMENDATION

For cleaning the glass module surfaces, aleo solar recommends:

- Rainwater without additives¹¹ with its temperature matching the temperature of the module.¹²
- A soft sponge or a soft brush.
- If necessary, use a telescopic rod with a sponge or soft brush attached on the end. The rod can have a water pipe integrated.
- For stubborn patches of dirt, use the following to help:
 - **Isopropanol:**
aleo solar recommends a mixture of isopropanol and rainwater to the ratio of 1:1.
 - **Glass cleaner:**
As an alternative, aleo solar recommends clear, colourless glass cleaner **with no ethanol or denaturants (e.g. Bitrex®)**¹³.

■ Anti-reflex glass

aleo modules have an anti-reflex layer on the glass surface to achieve a higher output. This means that some marks (e.g. fingerprints) are more visible than on normal glass. These marks are mostly seen as shimmering patches.

These kinds of marks do not have any measurable effect on the module output and fade away after about 2 weeks of being exposed to weather conditions, as sunlight and rain break them down.

11.4.3 Insulating back sheet

The insulating back sheet must not be cleaned. Nevertheless, if you still need to perform work behind the modules (e.g. to remove leaves):

- Make sure you refer to Ch. 6.2.1: „Electrical safety precautions“ and Ch. 6.2.2: „Mechanical safety precautions“.
- Avoid damaging the insulating back sheet.

¹⁰ Distilled or demineralised water is often used by cleaning services but can damage glass surfaces with frequent intensive use over long periods of time. aleo solar therefore advises against the use of distilled or demineralised water.

¹¹ Rainwater has a low level of water hardness. It is beneficial to use it because a build up of deposits is avoided.

¹² This prevents mechanical tension in the glass and ensures the module a longer service life.

¹³ Ethanol contains denaturants. Some denaturants can leave streaks behind or damage an anti-reflex layer.

11.4.4 More frequent cleaning

RECOMMENDATION

- In environments subject to heavy soiling, we recommend making the intervals for inspections and cleaning shorter than just once a year.
- For example, this applies to environments with a high exposure to dust, especially close to:
 - Large livestock farms
 - Grain reloading stations
 - Green areas with heavy foliage, seeds or pollen
 - Factories with high levels of dust emission.

aleo solar recommends contracting a specialised company to clean your photovoltaic generator properly without treading on the modules, if frequent cleaning is necessary.

11.5 Repairs

11.5.1 Modules

For repairing aleo modules, only contract technicians who have been authorised by aleo solar to avoid loss of warranty.

A defective module can cause loss of output, as well as consequential damage. If an aleo module needs repairing, first get in touch with aleo solar (see Ch. 2.2: „Contact“). Never, under any circumstances, repair an aleo module yourself.

Improper repairs can cause damage which may have repercussions years later, such as failure of electrical insulation. This could be fatal. Therefore, report any necessary repairs immediately.

Before you carry out any maintenance work on aleo modules, deactivate the module string or the whole generator if necessary. Observe the warnings and notes in Ch. 6.2.2: „Mechanical safety precautions“ and Ch. 6.2.1: „Electrical safety precautions“.

11.5.2 System parts

For repairing other system parts (e.g. substructure, connection boxes), contract authorised technicians to do the work or contact aleo solar directly (see Ch. 2.2: „Contact“).

12 For operators: decommissioning

12.1 Safety precautions

Make sure you refer to the notes in Ch. 6.2.1: „Electrical safety precautions“. If you would like to continue using the aleo module, also refer to Ch. 7.1: „Handling aleo modules“

12.2 Disposal

NOTE

- Dispose of the aleo modules at the end of their service life in the proper manner.
- To do this, contact a disposal company.
- Never dispose of aleo modules with household waste.

12.3 Returns

Aleo solar is member of PV CYCLE, used or damaged PV modules from aleo are covered by PV-CYCLE scheme without any costs.

PV CYCLE offers a comprehensive collection network for your PV module waste. From fixed collection points to on-site pick-up, find your collection service here.

Our collection and recycling service is free-of-charge* for modules of our members' brands. For free disposal, please first consult our brands search. For non-members' brands, please send the quotation request form to operations@pvcycle.org.

*Free service limited to max. 10t per request/pick-up. Special conditions apply to quantities larger than 10t (i.e. replacement or decommissioning of large installations, etc.).

12.4 PV Cycle

1 – 40 MODULES

PV CYCLE offers a broad network of fixed collection points for the disposal of small quantities.

1. Find your nearest PV CYCLE Collection Point under: <http://germany.pvcycle.org/> → Find collection point
2. Schedule an appointment with your preferred collection point
3. Download and complete the Delivery Request Form
4. Deliver your PV modules to the collection point
5. Receive a signed copy of your Delivery Request Form

80 – MORE MODULES

PV CYCLE offers on-site pick-up for the disposal of large quantities. The minimum quantity for the PV CYCLE direct pick-up service is 80 modules. **For quantities between 40 and 80 modules** special conditions apply to both members' and non-members' brands. Please contact operations@pvcycle.org for more information.

1. Schedule a pick-up at operations@pvcycle.org
2. Download and email the completed Pick-Up Request Form to operations@pvcycle.org.
3. Provide important information such as:
 - number of PV modules
 - available packaging (original packaging, pallets or other packaging unit)
 - number, overall size and weight of each packaging unit
 - address of the pick-up location
 - pictures of your end-of-life PV modules

IMPORTANT: Only complete Pick-Up Request forms can be treated in due time. PV modules meant for pick-up need to be appropriately packed for transport on the pallets or other packaging units in advance.

Contact address:

PV CYCLE Association

European Association for voluntary take back and recovering of photovoltaic modules A.I.S.B.L.

Renewable Energy House

Rue d'Arlon 63-67

1040 Brussels

BELGIUM

T +32 (0) 2880 72 50

F +32 (0) 2880 72 51

E info@pvcycle.org

W www.pvcycle.org

13 Notes